

TFS BASE KITCHEN MATIYALA DWARKA

16.10.2024

KITCHEN

IVORY WHITE EMULSION PAINT
CERAMIC WHITE 450 X 300
WITHOUT
GROOVE WITH WHITE MYK
LATIGRETE EPOXY GROUT

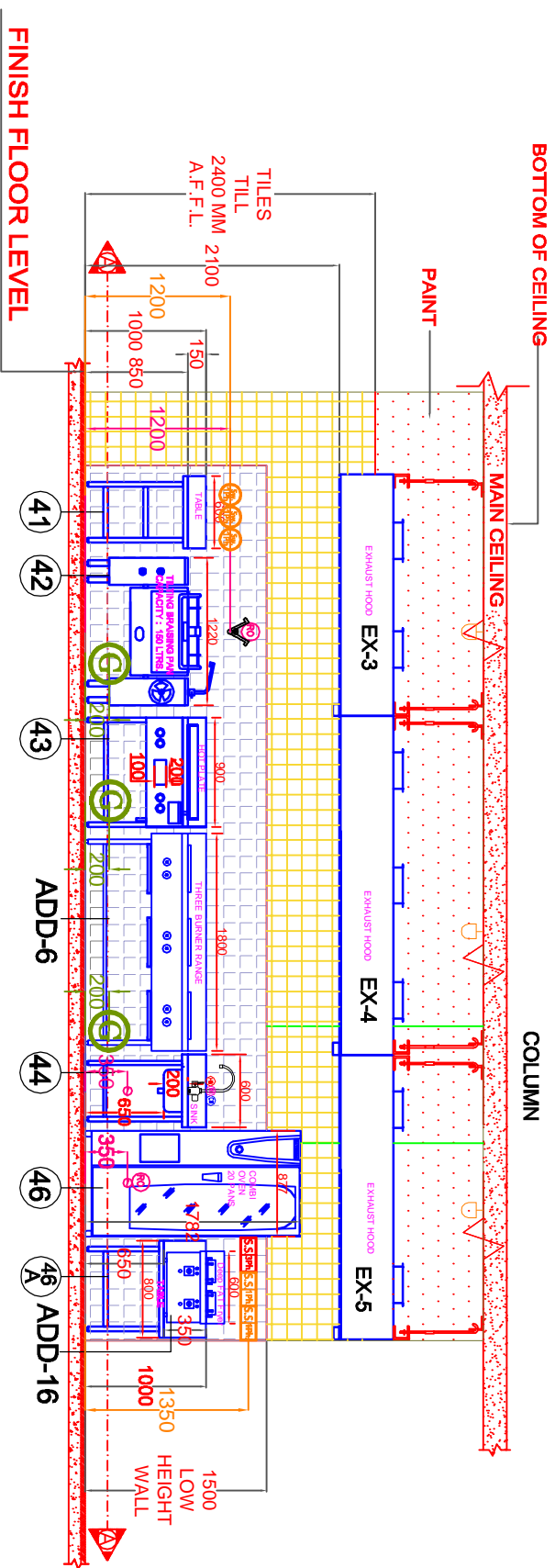
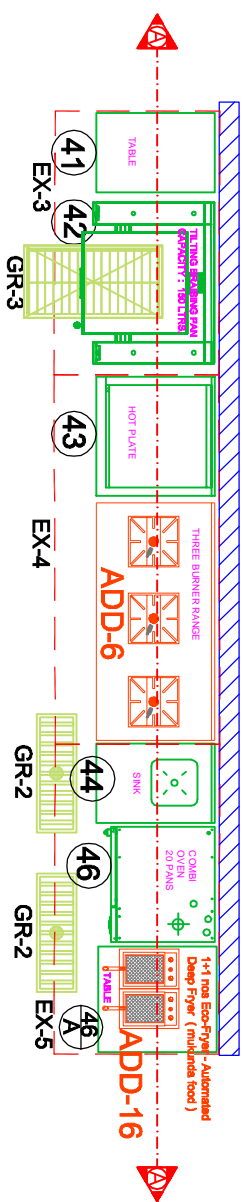

ELEVATION AA

SWITCH-@1200 MM A.F.F.L.
X 3 NOS.
CABLE OUT-LET SINGLE PHASE
220-50-1PH
0.5 K.W.
FOR HOOD LIGHT.
@ CEILING X 3 NOS.
SWITCH SOCKET THREE PHASE
440-50-3PH
36.8 K.W. FOR COMBI OVEN
@ 1350 MM AFFL
SWITCH SOCKET SINGLE PHASE
FOR ECO-FRYER
220-50-1PH 6.0 K.W.
@ 1350 MM
AFFL X 2 NOS.



G.D. OFFICE: 106, BLOCK C-3C, ROCKET 12, JANAK PURI, NEW DELHI, 110068
E-MAIL: design@cdsdesignsolutions.in OFFICE: +91 9212301725
THESE DRAWING AND SPECIFICATIONS ARE THE PROPERTY OF G.D.S. HOSPITALITY CONSULTANTS
AND SHALL NOT BE COPIED OR REPRODUCED WITHOUT THEIR WRITTEN PERMISSION.

PROJECT TITLE:
TFS
BASE KITCHEN
MATIYALA DWARKA

DRAWING TITLE:
ELEVATION AA

DESIGN ENGR.:	NO.	REVISION DATE
DRAWN BY: VIBHA	000	00/00/2024
	000	00/00/2024
	000	00/00/2024

PROJECT DATE:	16/10/2024/LAYOUT/REV000	SCALE:	NTS
PROJECT DATE:	16/10/2024/LAYOUT/REV000	SCALE:	NTS

TFS BASE KITCHEN MATTIYALA DWARKA 16.10.2024

PICK UP

IVORY WHITE EMULSION PAINT
CERAMIC WHITE 450 X 300
WITHOUT
GROOVE WITH WHITE MYK
LATCRETE EPOXY GROUT

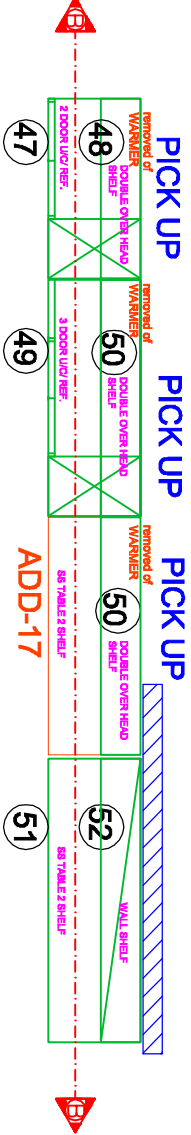

SWITCH SOCKET SINGLE PHASE
220-50-1PH
1.0 K.W. FOR SPARE
@1200 MM AFFL X 2 NOS.
SWITCH SOCKET SINGLE PHASE
220-50-1PH
1.0 K.W.
FOR SPARE
@1200 MM AFFL
X 2 NOS.
CABLE OUT-LET SINGLE PHASE
220-50-1PH
0.75 K.W.@ AFFL
FOR 2&3/D/U/C REF.
CABLE OUT-LET SINGLE PHASE
220-50-1PH
2.0 K.W. @ AFFL
FOR SPARE
SWITCH@1200 MM A.F.F.L
X 3 NOS.

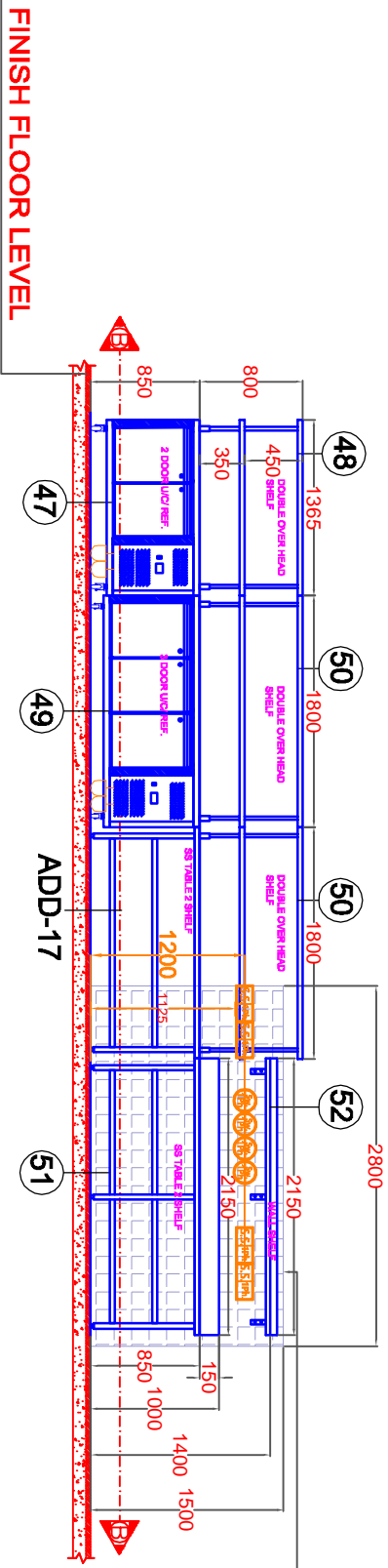

ELEVATION BB

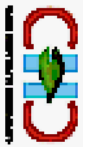

R.OFFICE: 106, BLOCK C-3C, POCERT 12, JANAK PUDA, NEW DELHI, 110058
e mail: design@sharadconcepts.com, in Office: +919212501725
THESE DRAWING AND SPECIFICATIONS ARE THE PROPERTY OF SHARAD CONSULTANTS AND SHALL NOT BE COPIED OR REPRODUCED WITHOUT THEIR WRITTEN PERMISSION.

PROJECT TITLE
TFS
BASE KITCHEN
MATTIYALA DWARKA

DRAWING TITLE:
ELEVATION BB

PROJECT DATE: 00.00.2024

DESIGN ENGR.:	NO.	REVISION DATE	REV NO.	REVISION DATE
	000	00/00/2024		
DRAWN BY:	000	00/00/2024		
VIBHA	000	00/00/2024		
	000	00/00/2024		

PROJECT DATE: 16/10/2024/LAYOUT/REV000

SCALE: NTS

TFS BASE KITCHEN MATIYALA DWARKA 16.10.2024

KITCHEN

IVORY WHITE EMULSION PAINT
CERAMIC WHITE 450 X 300
WITHOUT GROOVE WITH WHITE MYK
LATICRETE EPOXY GROUT

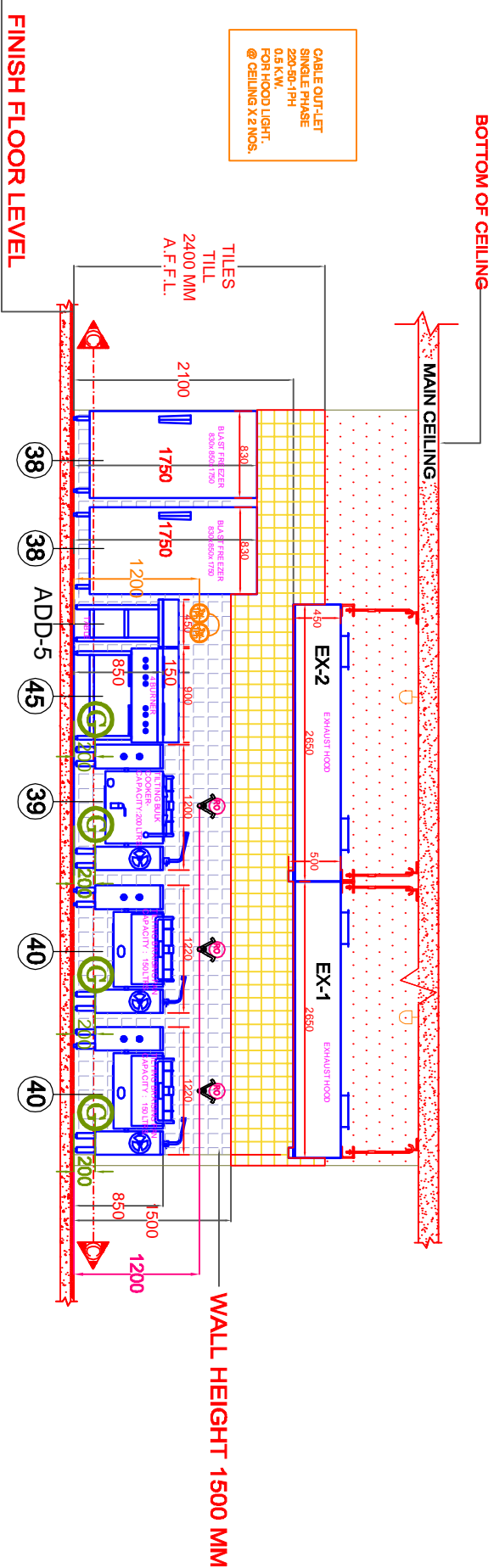
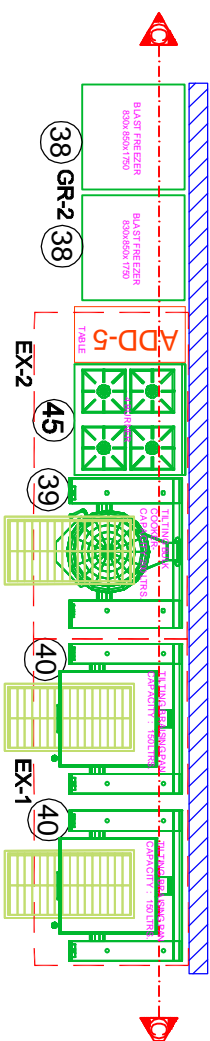

ELEVATION CC



K OFFICE: 186, BLOCK C-3C, ROCKET 12, JANAK PURI, NEW DELHI, 110088
 e mail: design@classconsultants.in Office: 919212301725
 THIS DRAWING AND SPECIFICATIONS ARE THE PROPERTY OF CLASSCONSULTANTS AND SHALL NOT BE COPIED OR REPRODUCED WITHOUT THEIR WRITTEN PERMISSION

PROJECT TITLE
**TFS
 BASE KITCHEN
 MATIYALA DWARKA**

DRAWING TITLE:
ELEVATION CC

PROJECT DATE: 00.00.2024

DESIGN ENGR.:	NO.	REVISION DATE	REV NO.	REVISION DATE
DRAWN BY: VIBHA	000	00/00/2024		
	000	00/00/2024		
	000	00/00/2024		
	000	00/00/2024		

SCALE: NTS

TF'S BASE KITCHEN MATTIYALA DWARKA 16.10.2024

KITCHEN

IVORY WHITE EMULSION PAINT
CERAMIC WHITE 450 X 300 WITHOUT GROOVE WITH WHITE MYK LATICRETE EPOXY GROUT

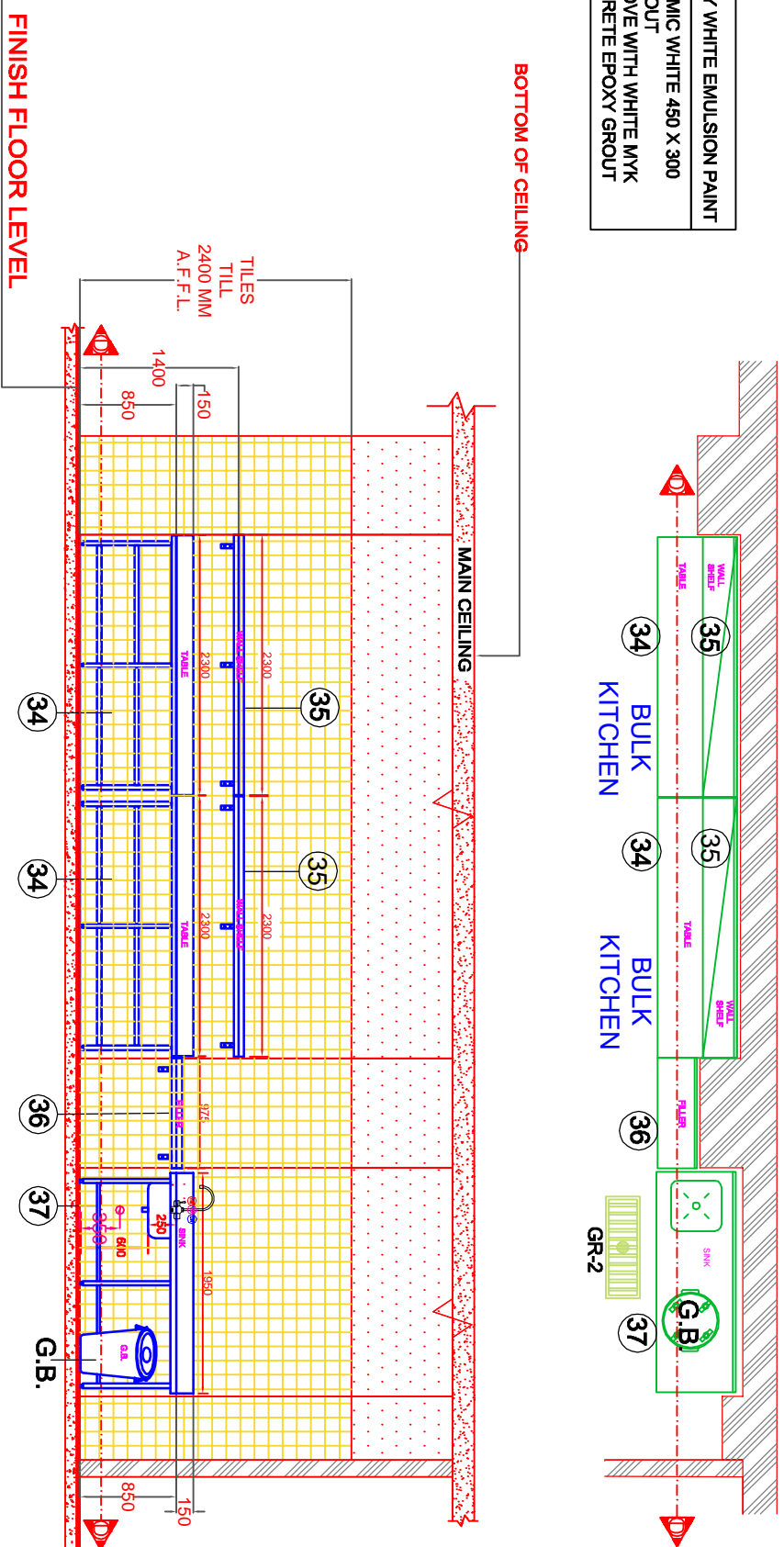

ELEVATION DD

PROJECT TITLE

TF'S
BASE KITCHEN
MATTIYALA DWARKA

DRAWING TITLE:

ELEVATION DD

DESIGN ENG'R.:

NO.

REVISION DATE

REV NO.

REVISION DATE

DRAWN BY:

000

00/00/2024

00/00/2024

VISHA

000

00/00/2024

00/00/2024

PROJECT DATE: 00.00.24

16/10/2024/LAYOUT/REV000

SCALE: NTS

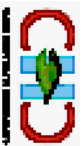

R.OFFICE: 186, BLOCK C-3C, FACKET 12, ANNA PURI, NEW DELHI 11008
e mail: design@classconsultants.in Office:+91212501725
THESE DRAWING AND SPECIFICATIONS ARE THE PROPERTY OF CLASS HOSPITALITY CONSULTANTS AND SHALL NOT BE COPIED OR REPRODUCED WITHOUT THEIR WRITTEN PERMISSION

TFS BASE KITCHEN MATTIYALA DWARKA 16.10.2024

COLD ROOM

IVORY WHITE EMULSION PAINT
CERAMIC WHITE 450 X 300
WITHOUT
GROOVE WITH WHITE MTK
LATITECRE EPOXY GROUT

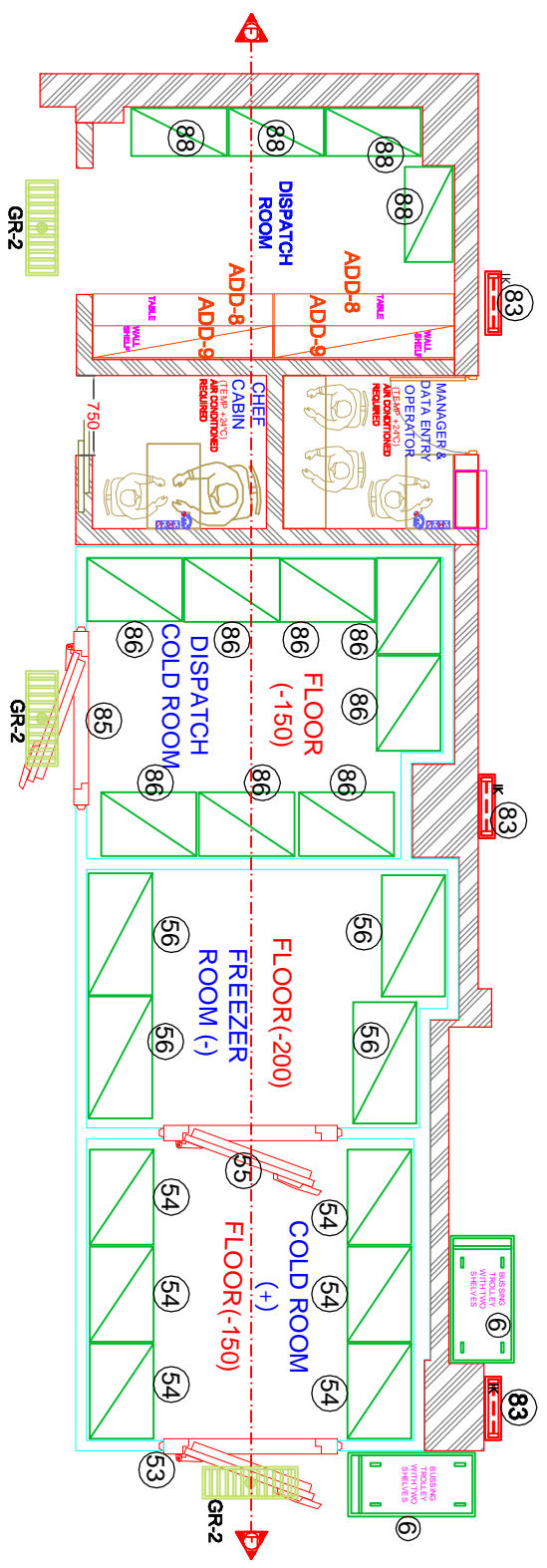

CABLE OUTLET THESE PHASE 400-0-0-1H
6.0 KW FOR COLD ROOM
SWITCH @ 1500 MM A.F.L.
CABLE OUTLET SINGLE PHASE 200-0-0-1PH
1.0 KW FOR COLD ROOM
SWITCH @ 1500 MM

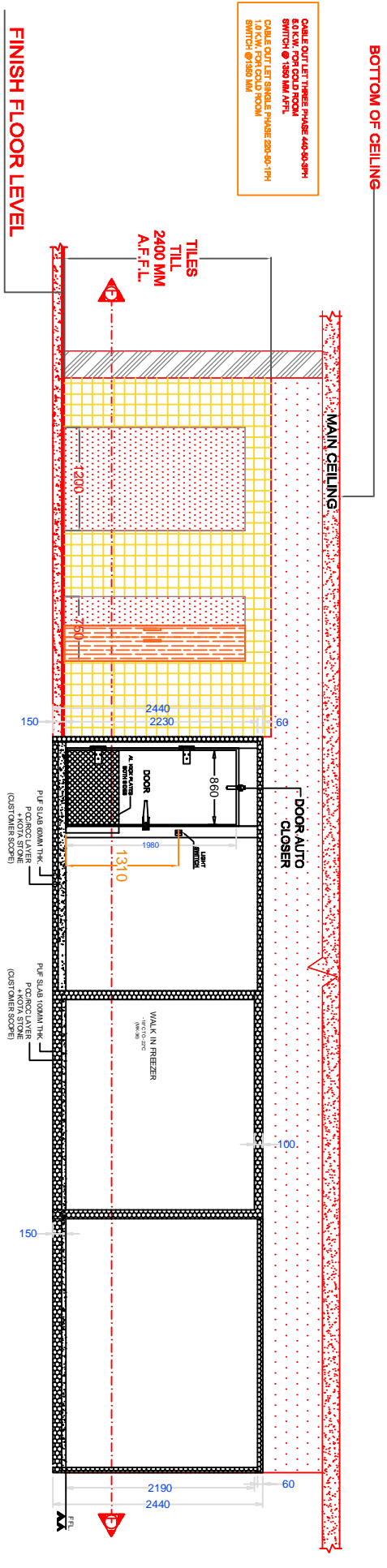

ELEVATION FF

3. OFFICE: 106, BLOCK C-02, ROCKET 12, JANAK PURI, NEW DELHI, 110088
 6. EMAIL: design@clashhospitality.com | 011-2212301723
 THESE DRAWING AND SPECIFICATIONS ARE THE PROPERTY OF CLASH HOSPITALITY CONSULTANTS AND SHALL NOT BE COPIED OR REPRODUCED WITHOUT THEIR WRITTEN PERMISSION.

PROJECT TITLE:
TFS
BASE KITCHEN
MATTIYALA DWARKA

DRAWING TITLE:
ELEVATION FF

DESIGN ENGR.:
VIBHA

DRAWN BY:
VIBHA

PROJECT DATE: 00.00.24

NO.	REVISION DATE	REV NO.	REVISION DATE
000	00/00/2024		
000	00/00/2024		
000	00/00/2024		
000	00/00/2024		

SCALE: NTS

**TFS BASE KITCHEN
MATIYALA DWARKA
16.10.2024**

CONFECTIONARY

NORY WHITE EMULSION PAINT
CERAMIC WHITE 450 X 300 WITHOUT GROOVE WITH WHITE MKK LATICRETE EPOXY GROUT

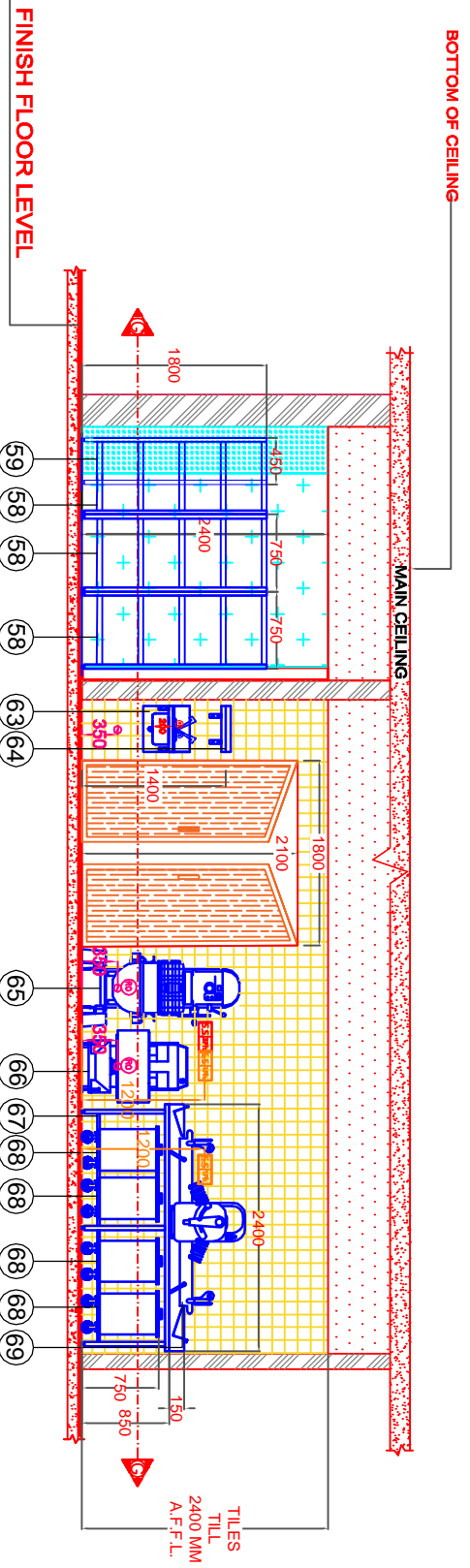
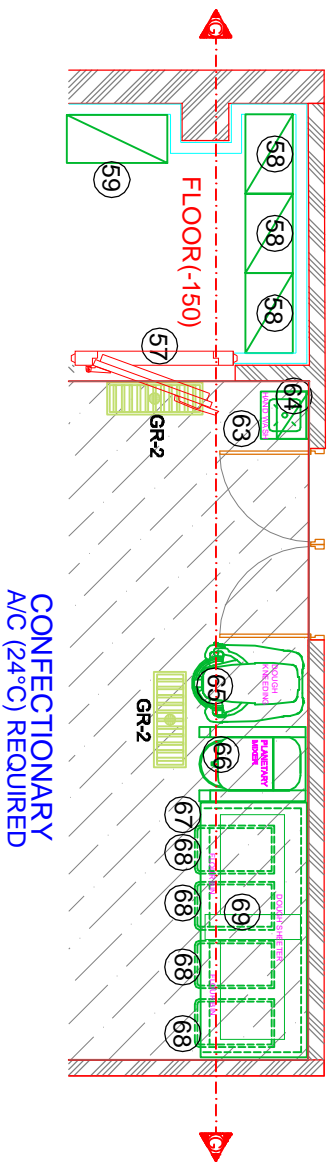

ELEVATION GG

SWITCH SOCKET SINGLE PHASE 250-30-1PH 0.750 KW, RCR PLASTIC MOUNTING @ 1200 MM A/F.T.L.
SWITCH SOCKET THREE PHASE 440-50-3PH 5.0 KW, RCR DOLBY KNEADER @ 1200 MM A/F.T.L.
SWITCH SOCKET SINGLE PHASE 250-30-1PH 0.750 KW, RCR DOLBY SHEETER @ 1200 MM A/F.T.L.



CLASS CONSULTANTS
ENGINEERS ARCHITECTS

3, LOBBY, 1/8, BLOCK C-2C, POCKET 12 JAYAK RIVER, NEW DELHI, 110083
e mail: design@classconsultants.in Office: +91 9212501775
THESE DRAWING AND SPECIFICATIONS ARE THE PROPERTY OF CLASS CONSULTANTS AND SHALL NOT BE COPIED OR REPRODUCED WITHOUT THEIR WRITTEN PERMISSION.

PROJECT TITLE
TFS
BASE KITCHEN
MATIYALA DWARKA

DRAWING TITLE:
ELEVATION GG

PROJECT DATE: 00.00.24

DESIGN ENGR.:	NO.	REVISION DATE	REV NO.	REVISION DATE
DRAWN BY: VIBHA	000	00/00/2024		
	000	00/00/2024		
	000	00/00/2024		
PROJECT DATE: 16/10/2024/LAYOUT/REV000		SCALE: NTS		

TFS BASE KITCHEN
MATIYALA DWARKA
16.10.2024

CONFECTIONARY
BAKERY

- MORRY WHITE EMULSION PAINT
- CERAMIC WHITE 450 X 300
- WITHOUT GROOVE WITH WHITE MKK
- LATICRETE EPOXY GROUT

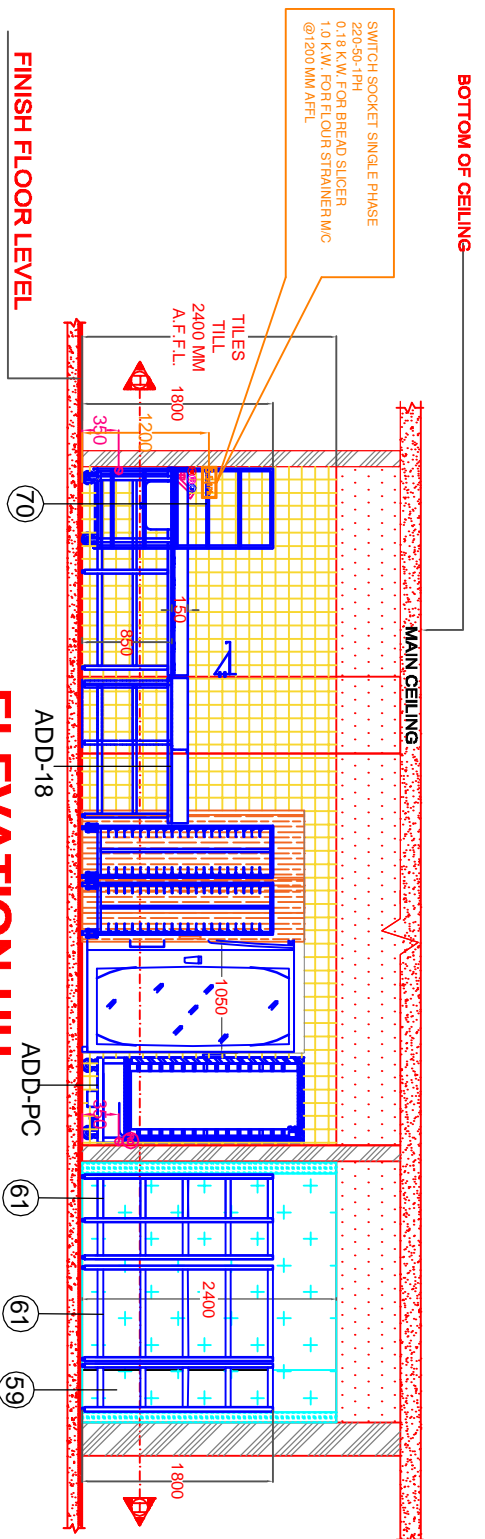
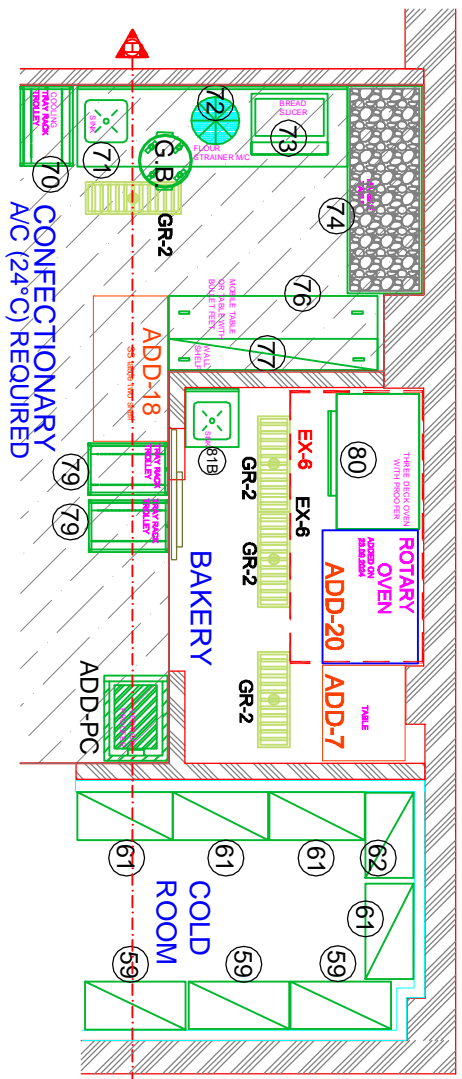

ELEVATION HH



CLASS INTERIM CONSULTANCY

3, ROBERTS, 18K, BLOCK C-2C, ROCKET 12 ANNAK RIVER, NEW DELHI, 11008
 e mail: design@classinterim.com | Office: +91 9212501725
 THESE DRAWING AND SPECIFICATIONS ARE THE PROPERTY OF CLASS INTERIM CONSULTANCY AND SHALL NOT BE COPIED OR REPRODUCED WITHOUT THEIR WRITTEN PERMISSION.

PROJECT TITLE

TFS
 BASE KITCHEN
 MATIYALA DWARKA

DRAWING TITLE:

ELEVATION HH

PROJECT DATE: 00.00.24

DESIGN ENGR.:

NO.

REVISION DATE

REV NO.

REVISION DATE

DRAWN BY:

NO.

REVISION DATE

VIBHA

NO.

REVISION DATE

16/10/2024/LAYOUT/REV000

SCALE: NTS

TFS BASE KITCHEN
MATIYALA DWARKA
16.10.2024

BAKERY

IVORY WHITE EMULSION PAINT
 CERAMIC WHITE 480 X 300
 WITHOUT
 GROOVE WITH WHITE MYK
 LATICRETE EPOXY GROUT

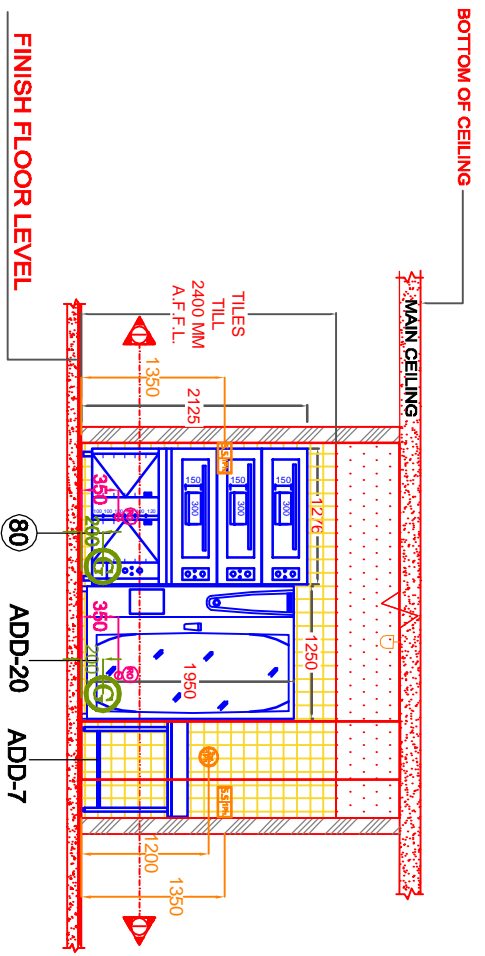
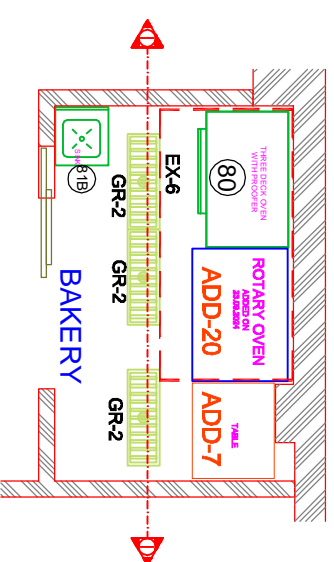

SWITCH@1200 MM A.F.F.L.
 X 3 NOS.
 SWITCH SOCKET SINGLE PHASE
 220-50-1PH
 3.0 K.W. FOR
 3 D/OVEN
 @1350 MM AFFL
 CABLE OUT-LET SINGLE PHASE
 220-50-1PH
 0.5 K.W.
 FOR HOOD LIGHT
 @ CEILING
 SWITCH SOCKET SINGLE PHASE
 220-50-1PH
 3.0 K.W. FOR
 ROTARY OVEN
 @1350 MM AFFL

ELEVATION II

 <p>CLASS HERITAGE CONSULTANTS</p> <p>3, LOBBY - 18, BLOCK C-2C, PLOT 12 ANNAK RIVER, NEW DELHI, 110088 e mail: design@classheritage.com Office: +91 9212501725 THESE DRAWING AND SPECIFICATIONS ARE THE PROPERTY OF CLASS HERITAGE CONSULTANTS AND SHALL NOT BE COPIED OR REPRODUCED WITHOUT THEIR WRITTEN PERMISSION.</p>		<p>PROJECT TITLE</p> <p>TFS BASE KITCHEN MATIYALA DWARKA</p>		<p>DRAWING TITLE:</p> <p>ELEVATION II</p> <p>PROJECT DATE: 00.00.24</p>	
<p>DESIGN ENGR.:</p> <p>NO.</p>		<p>REVISION DATE</p>		<p>REV NO.</p>	
<p>DRAWN BY:</p> <p>VJBHA</p>		<p>00/00/2024</p> <p>00/00/2024</p> <p>00/00/2024</p>		<p>000</p> <p>000</p> <p>000</p>	
<p>PROJECT DATE: 16/10/2024/LAYOUT/REV000</p>		<p>SCALE: NTS</p>			

TFS BASE KITCHEN
MATIYALA DWARKA
16.10.2024

VEG PREP

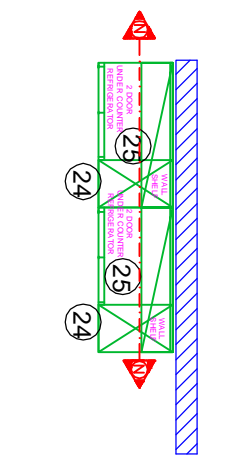
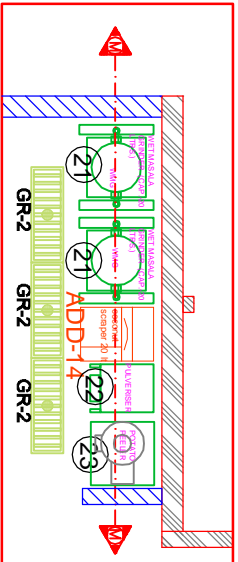
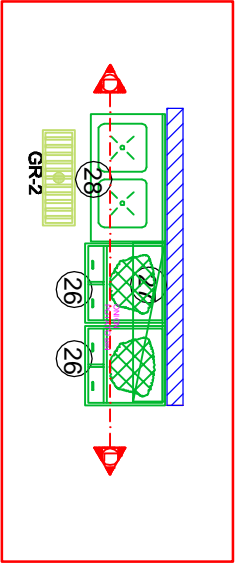

IVORY WHITE EMULSION PAINT
 CERAMIC WHITE 450 X 300
 WITHOUT
 GROOVE WITH WHITE NYK
 LATIGRETE EPOXY GROUT

SWITCH SOCKET THREE PHASE
 440-50-3PH/1.5 K.W X 5
 FOR WET MASAVALA GRINDER
 FOR 1400 W. BLENDER, PULVERISER
 @ 1950 MM AFFL.
 SWITCH SOCKET SINGLE PHASE
 225-50-1PH/
 0.75 K.W. FOR
 2/0V/GR/REF.
 1.0 KW. FOR SPARE
 @1200 MM AFFL.

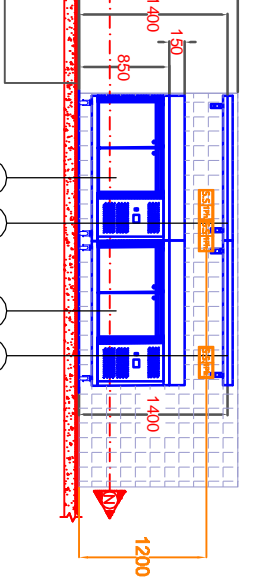
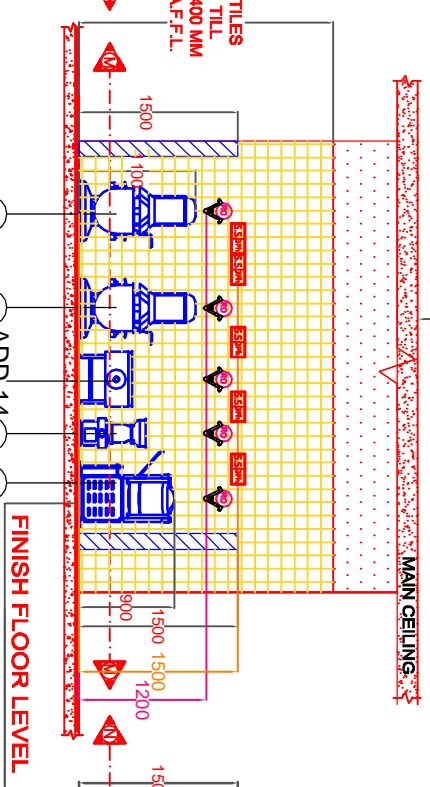
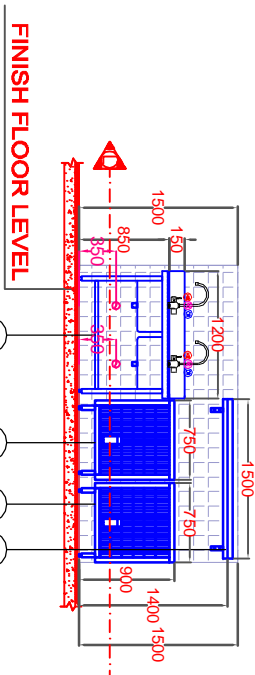

ELEVATION-LL

ELEVATION-MM

ELEVATION-NN



CLASS INTERIORYT CONSULTANCY

3 OFFICE: 1/8, BLOCK C-2C, POCKET 12 ANAK RIVER, NEW DELHI, 110085
 e mail: design@classinterioryt.com | Office: +91 9212501725
 THESE DRAWING AND SPECIFICATIONS ARE THE PROPERTY OF CLASS INTERIORYT CONSULTANCY
 AND SHALL NOT BE COPIED OR REPRODUCED WITHOUT THEIR WRITTEN PERMISSION.

PROJECT TITLE

TFS
 BASE KITCHEN
 MATIYALA DWARKA

DRAWING TITLE:

ELEVATION
 LL&MM&NN

PROJECT DATE: 00.00.24

DESIGN ENGR.:

NO.

REVISION DATE

REV NO.

REVISION DATE

DRAWN BY:

000

00/00/2024

000

00/00/2024

VIBHA

000

00/00/2024

000

00/00/2024

16/10/2024/LAYOUT/REV000

SCALE: NTS

**TFS BASE KITCHEN
MATIYALA DWARKA
16.10.2024**

RECEIVING

NORY WHITE EMULSION PAINT
CERAMIC WHITE 450 X 300
WITHOUT
GROOVE WITH WHITE MYK
LATICRETE EPOXY GROUT

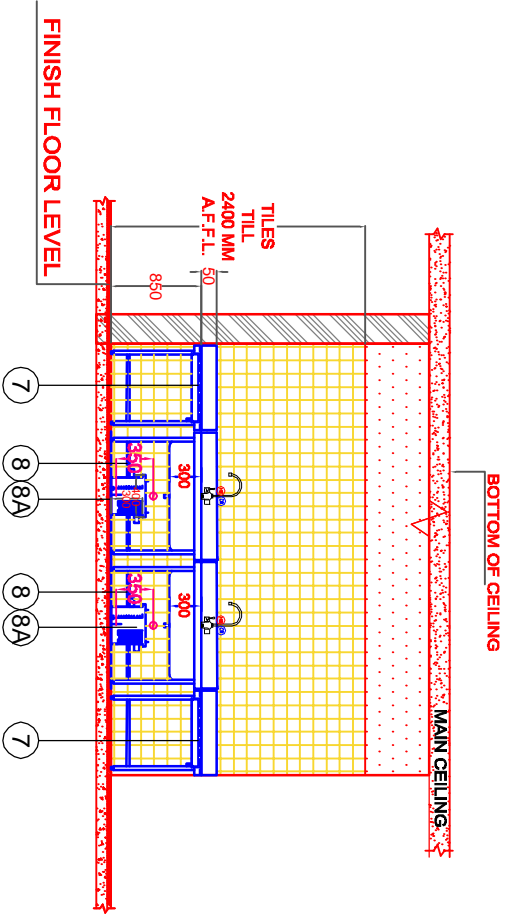
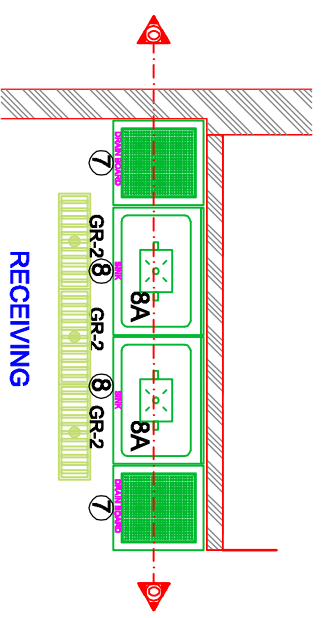

ELEVATION-00

CLASS CONSULTANTS ENGINEERS

3, LOBBY, 18, BLOCK C-2, POCKET 12 ANAK RIVER, NEW DELHI, 11008
 e mail: design@classconsultants.in Office+919212501725
 THESE DRAWING AND SPECIFICATIONS ARE THE PROPERTY OF CLASS CONSULTANTS AND SHALL NOT BE COPIED OR REPRODUCED WITHOUT THEIR WRITTEN PERMISSION.

PROJECT TITLE
**TFS
 BASE KITCHEN
 MATIYALA DWARKA**

DRAWING TITLE:
ELEVATION 00

PROJECT DATE: 00.00.24

DESIGN ENGR.:	NO.	REVISION DATE	REV NO.	REVISION DATE
DRAWN BY: VIBHA	000	00/00/2024		
	000	00/00/2024		
	000	00/00/2024		
PROJECT DATE: 16/10/2024/LAYOUT/REV000		SCALE: NTS		